

CogSysIII Lecture 2: Perception and Ergonomics

Human Computer Interaction
SS 2006

Ute Schmid (lecture)

Emanuel Kitzelmann (practice)

Applied Computer Science, Bamberg University

Perception

- Information acquisition from the environment via sense organs and transformation into experiences of objects, events, sounds, tastes, etc.
- Vision as dominant and best researched of senses (followed by hearing and touch)
- Perception is not passive: projection of information from the environment on the retina
but: result of internal processes on the “raw data”!
- bottom-up and top-down processes

Sense Organs



- visuell
- auditiv
- haptisch
- olfaktorisch
- gustatorisch

Bottom-up and Top-down Processes

- Early vision (mostly bottom-up):
 - Encoding of orientation of lines, angles, colors
- Strong influence of cognition, interpretation (top-down)
 - Object identification
- “middle ground”
 - Perception of depth, distance, movement

Introduction to Visual Perception

- Physiological basis of vision
- Perceiving brightness and contrast
- Color Perception
- Perceiving depth
- Object perception

E. Bruce Goldstein, Sensation and Perception

J. Müsseler, Visuelle Wahrnehmung, in Müsseler & Prinz,
Allgemeine Psychologie

Stimuli for Vision

- Visible light: 360 to 700 nm
- Reflection of light from objects into our eyes
- Distal stimulus: physical size and distance of an object
- Proximal stimulus: stimulus located on the observers receptors (retinal size and visual angle)
- Projection on the retina is upside down!
- Visual angle is determined by size and distance of an object

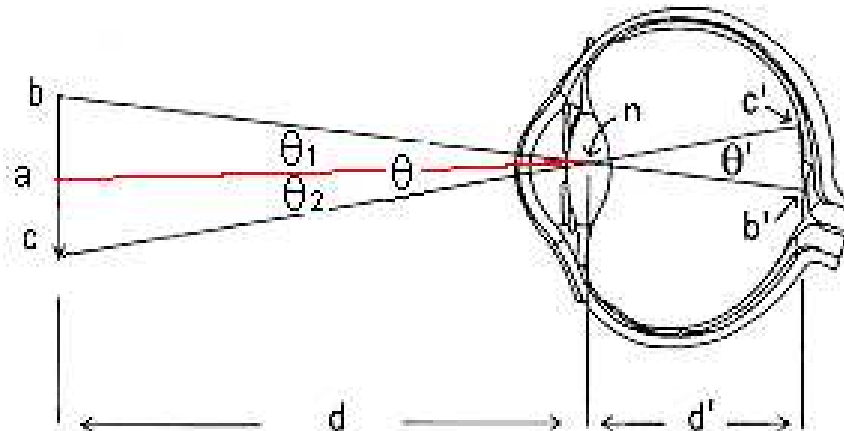

Size Perception

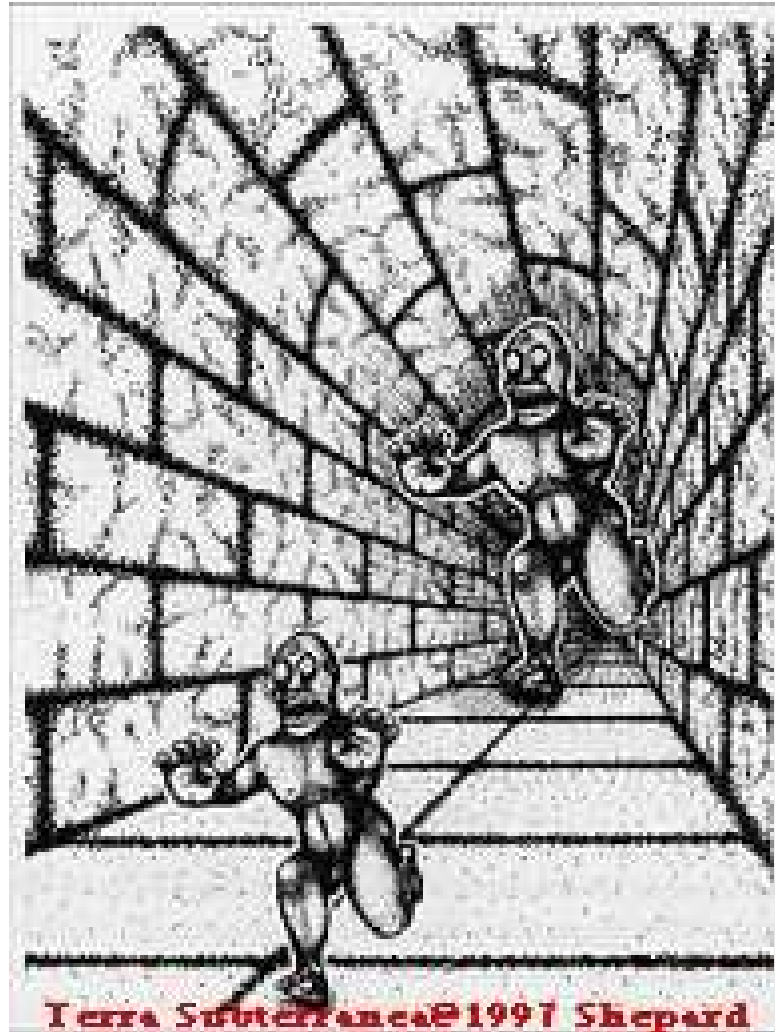

Retina

The Human Eye

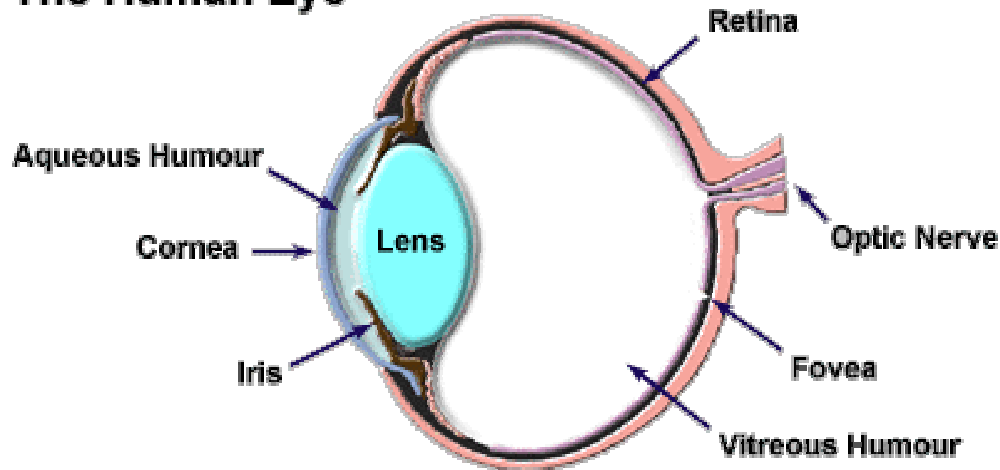

The Retina

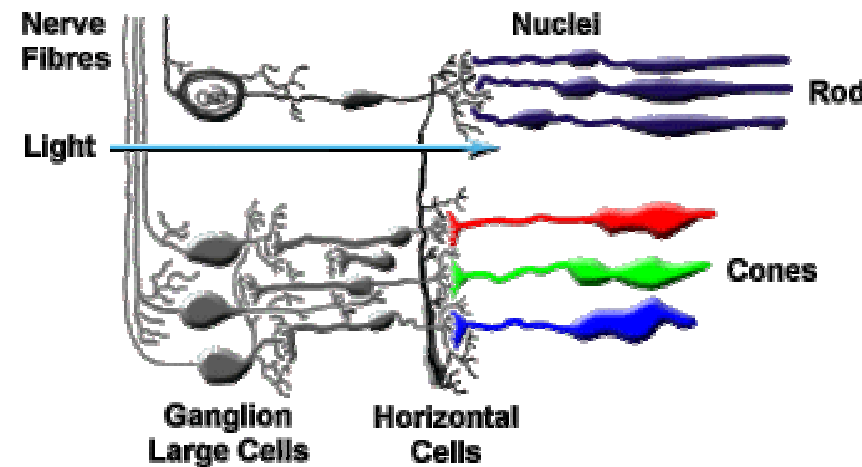

- ca. 126 Mio photo receptors in the retina
- 120 Mio rods (higher sensitivity for light)
- 6 Mio cones (color vision, mostly near fovea)
- positioned in the back of the eye
- Receptive field of a neuron: area on the receptor surface (retina) that, when stimulated, affects the firing of that neuron

The Blind Spot

- Where the optic nerve leaves the eye are no receptors (blind spot)
- Usually, we are not aware of the blind spot – no “hole” in our perception
- Seeing with two eyes: different blind spots, merging of the images of both eyes in higher cortical structures
- blind spot is off to the side of our visual field, i.e. not in focus
- Mechanism to “fill in” the blind spot
- Demo: close right eye, focus cross with left eye, move back and forth, circle disappears (replaced by color/pattern of surrounding area)

Demo “Blind Spot”

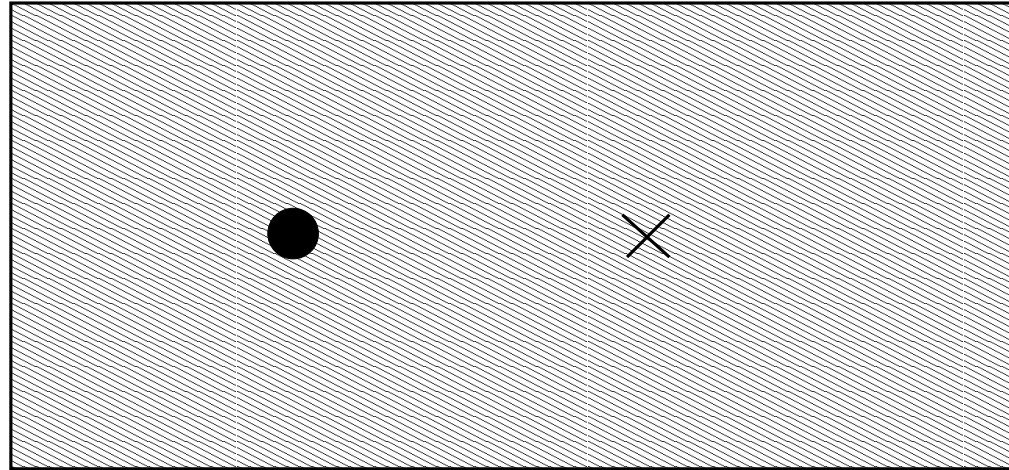

Visual Pathway

- from retina to lateral geniculate nucleus (LGN) (cross over to the opposite site in the cortex)
- most nerve fibres go to the visual cortex (occipital lobe)
- some go to the Superior colliculus (control of eye movement)

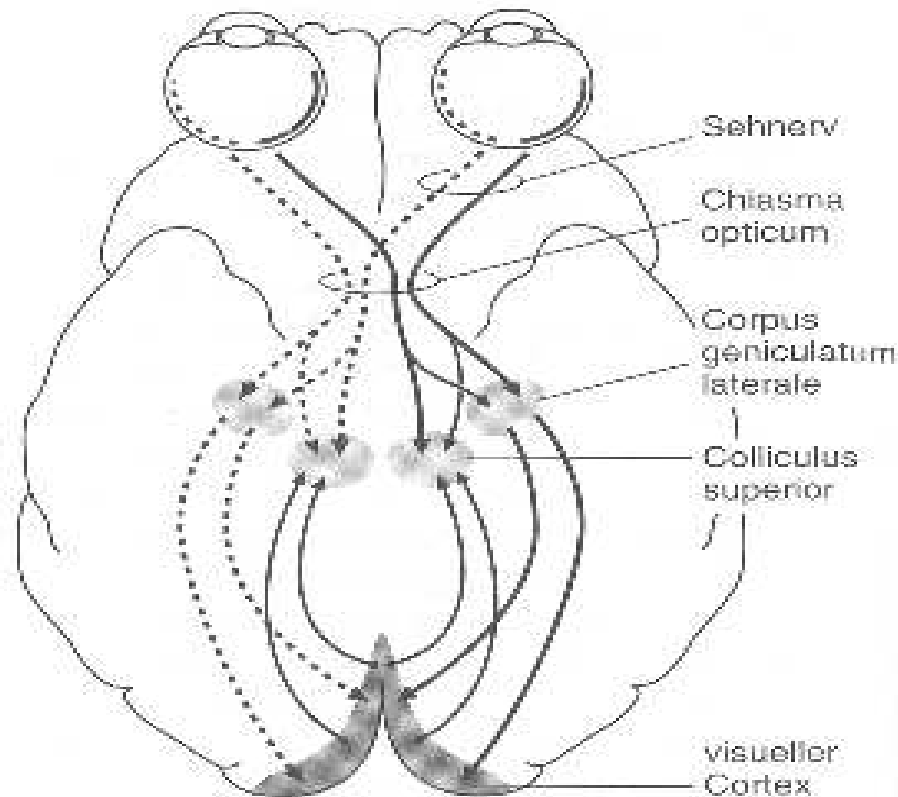

Spectral Sensitivity

- Cones more sensitiv in light
- Rods more sensitiv in dark
- Rods have greater sensitivity in low ambient illumination

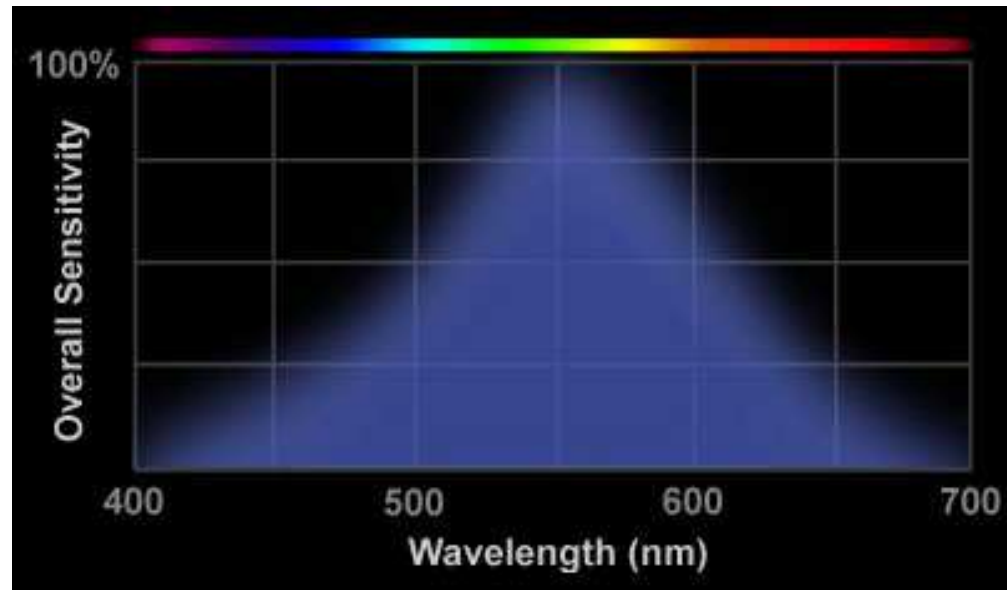

Measurement of Sensitivity

- Psychophysics: Relation between physical stimuli and perception
- Absolute threshold: smallest amount of stimulus energy needed for an observer to detect the stimulus
 - Method constant stimuli: present five to nine stimuli with the most intense clearly above threshold and least intense clearly below threshold, presentation in random order
 - Method of limits: presentation in ascending or descending order
 - Method of adjustment: intensity is slowly changed by observer or experimenter
- Difference threshold: just noticeable differences
- Weber's law: $JND = K \times S$
 - S as size of a standard stimulus (e.g. weight of 100 gram)
 - Constant K : specific for different kinds of stimuli (e.g. 0.03 for weight in grams)

Perception of Brightness

- Perception of intensity of light reflected from a surface
- Intensity of illumination and reflectance of the surface
- Mach bands, explanation by lateral inhibition
 - To the left of the point where the figure just starts to get lighter people usually see a dark bar that is slightly darker than the area to the left of it.
At the point where the brightness just stops increasing, people usually perceive a bright bar.

Mach Bands and Lateral Inhibition

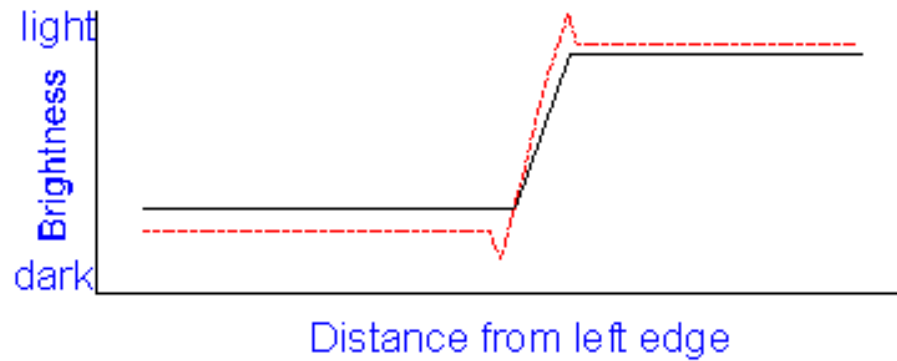
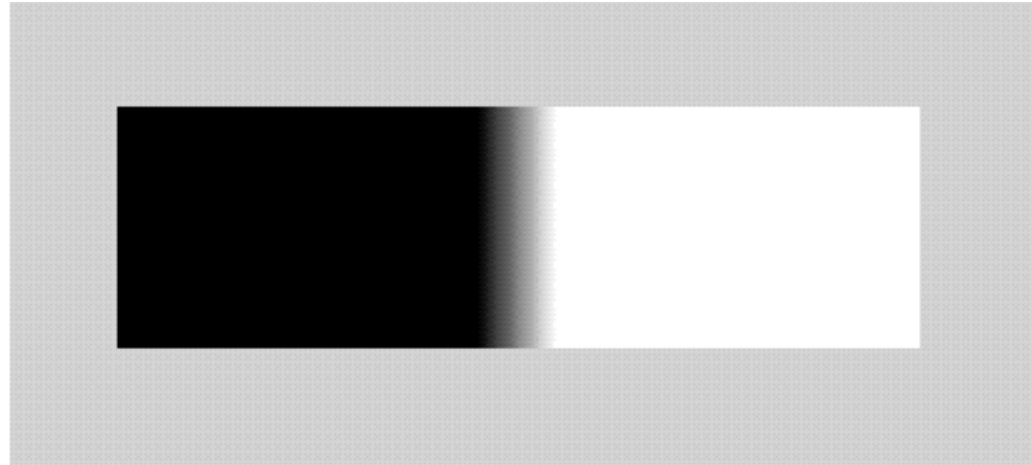

Mach Bands and Lateral Inhibition

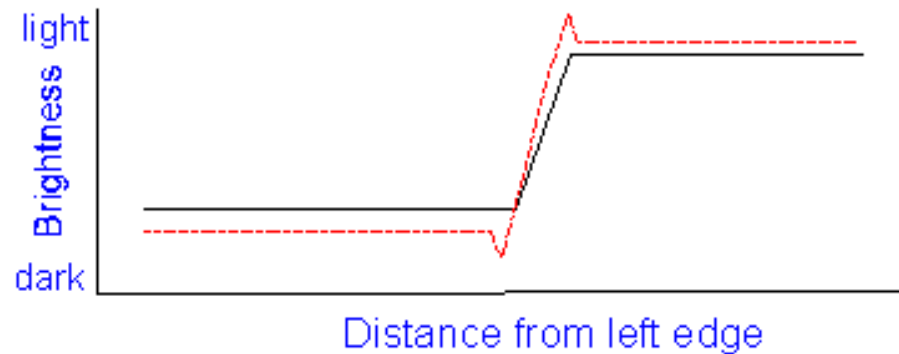
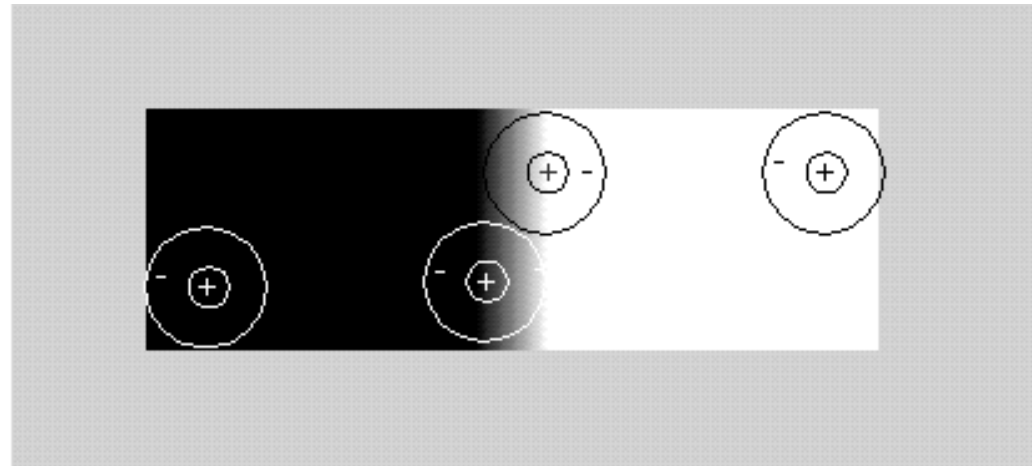

- center-surround receptive field interactions
- The receptive fields are represented as a disk (+) and annulus (-).
- The center disk is an excitatory area and the annulus an inhibitory area.

Lateral Inhibition

- The receptive fields in the uniformly white and uniformly black areas receive about the same stimulation in their excitatory centers and inhibitory surrounds.
- Therefore the center excitations are in balance with the surround inhibitions.
- The receptive field over the bright Mach Band gives a stronger response in the center because part of the surround is in the darker area. Therefore it receives less inhibition from the surround than did the center at the extreme left and right ends.
- The receptive field over the dark band receives more surround inhibition because part of the surround is in the brighter area. Therefore, the excitatory response is less and this results in our seeing that the area as darker.

Perception of Contrast

- Perception of brightness in two adjacent areas: simultaneous contrast
- Physical contrast and perceptual contrast do not always correspond!
- A disc with blurred contours with a similar intensity as a surrounding area will “disappear”!

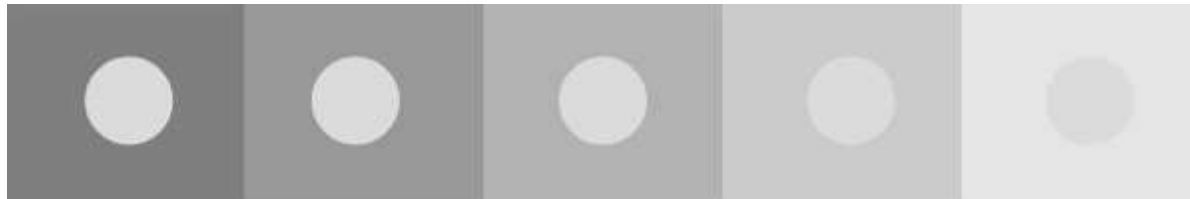

Ergonomics

- application of scientific information concerning humans to the design of objects, systems and environment for human use.
- comes into everything which involves people: Work systems, sports and leisure, health and safety should all embody ergonomics principles
- incorporates elements from many subjects: anatomy, physiology, psychology and design
- ensure that products and environments are comfortable, safe and efficient for people to use
- Ergonomic design: considering design options to ensure that people's capabilities and limitations are taken into account; helps to ensure that the product is fit for use by the target users

Cognitive Ergonomics

- focuses on the fit between human cognitive abilities and limitations and the machine, task, environment, etc.
- Example applications:
 - designing a software interface to be "easy to use"
 - designing a sign so that the majority of people will understand and act in the intended manner
 - designing an airplane cockpit or nuclear power plant control system so that the operators will not make catastrophic errors

Consequences for Design

- Be aware of simultaneous contrast effects (also in color)
- Make differences in brightness prominent



Color Perception

- Definition of color in terms of spectral composition: wavelength
- Our eyes have three sets of sensors with peak sensitivities at light frequencies that we call red (580 nm), green (540 nm) and blue (450 nm)
- Light at any wavelength in the visual spectrum range from 400 to 700 nanometres will excite one or more of these three types of sensors
- Our perception of which color we are seeing is determined by which combination of sensors are excited and by how much
- Humans can perceive about 150 different hues

Color Wheel

- In combination with saturation (perc. of color in white) and brightness (perc. of black), we can perceive about 7 Mio colors
- There exist 7500 different names for colors (National Bureau of Standards, USA)
- Additive color mixture (wavelength); mixing red, green, blue results in white
- Subtractive color mixture (mixing paints), reflection of wavelengths common two mixed colors; mixing red, green, blue results in black



Visible Hues

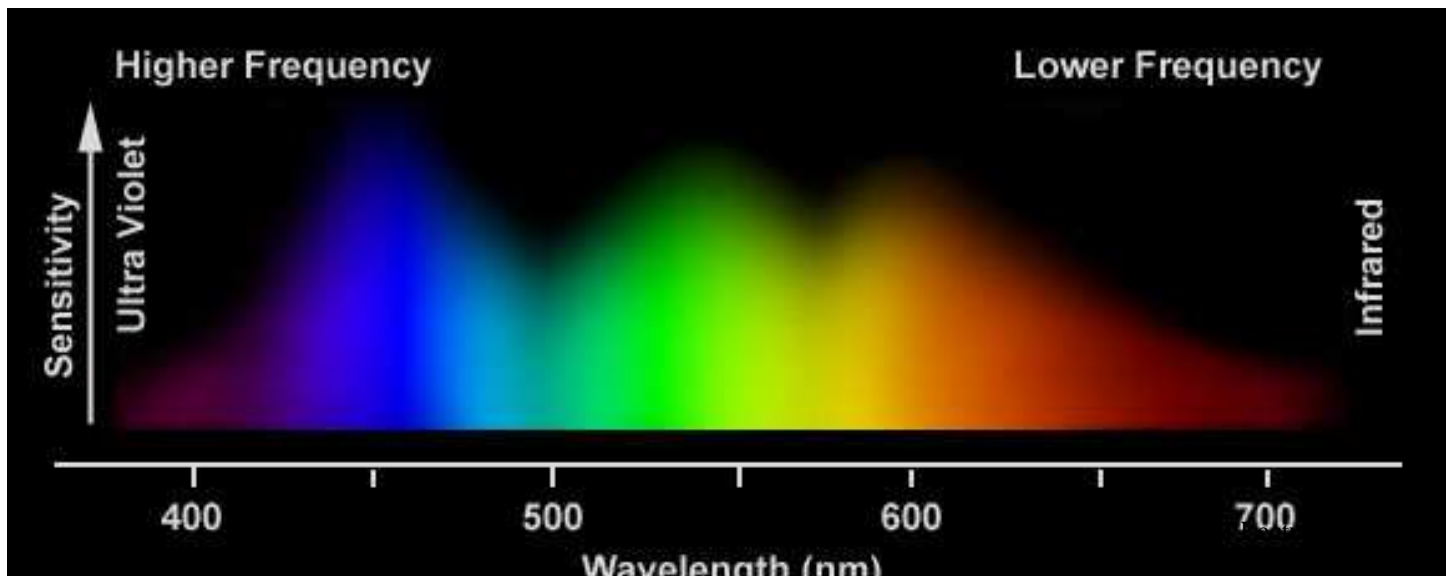
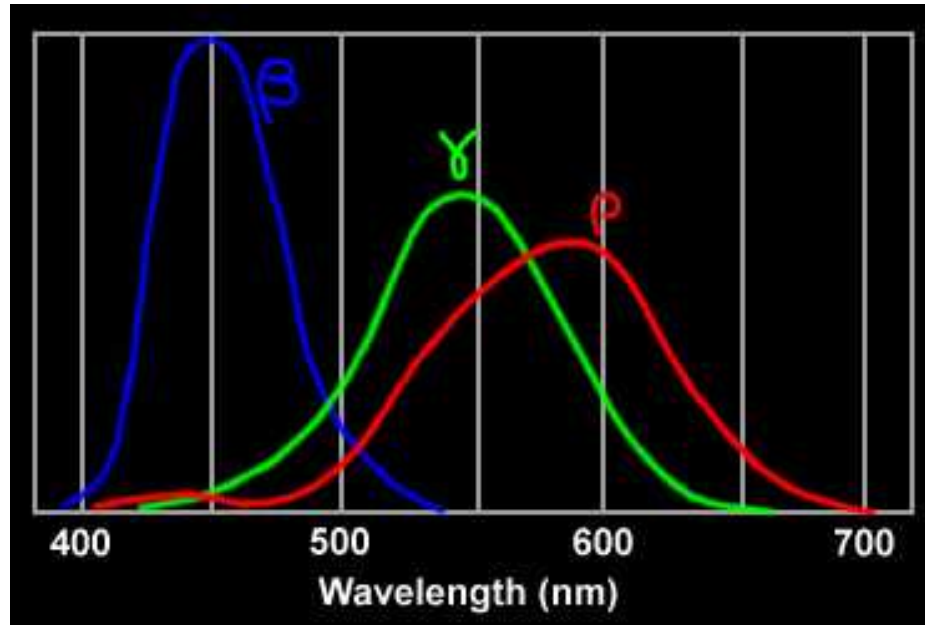

Color Blindness

- Some people have a visual anomaly referred to as color blindness and have trouble distinguishing between certain colors.
- Red-green color blindness could occur if the Rho and Gamma sensor curves exactly overlapped or if there were an insufficient number of either rho or gamma sensors.
- A person with this affliction might have trouble telling red from green, especially at lower illumination levels.

Color as a Private Experience

- Experiments show that color perception is stable for one observer but that there exist significant differences between observers
- E.g.: show the purest green (500 nm, 505 nm)

Successive Contrast/Afterimage

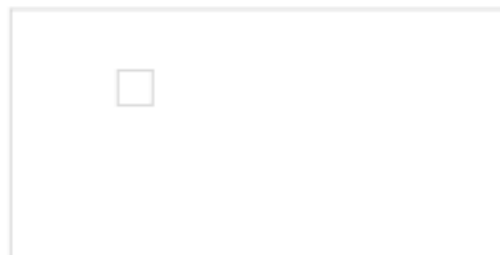
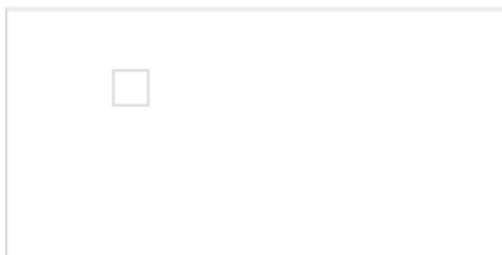
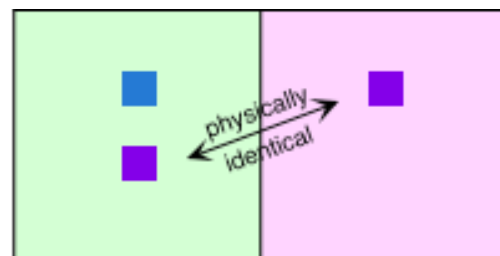
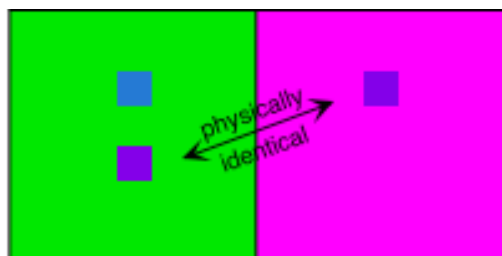
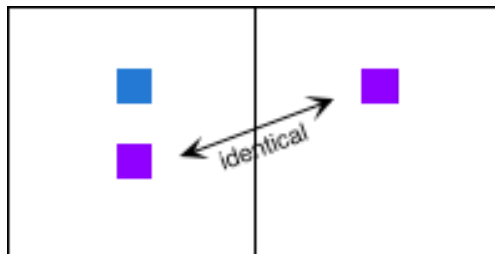

Successive Contrast/Afterimage

- effect of previously-viewed color fields on the appearance of the currently-viewed test field.
- Demo: pay attention to only the colors of the background fields, stare at the top left blue square on the green background for 5-10 seconds, then look at the small outline square below. You should clearly see the aftereffect of the green and magenta background fields as faint magenta and green fields, respectively. Now repeat the 5-10 seconds to build up the afterimage again and then look at the upper left square on the pastel green and magenta backgrounds (upper right panel). The afterimage should be strong enough to make these backgrounds look gray or even reverse their appearances, with a pale magenta appearance on the left and pale green on the right.

Consequences for Design of Graphics

see: <http://colorusage.arc.nasa.gov>

- find two different physical colors for two test fields on different backgrounds that have the same appearance
- not a universal solution:
 - difficult to apply in dynamic graphics, e.g., moving maps, in which the symbols move from one background color to another. The physical color of each symbol would have to be changed to a different color when it moved to a new background.
 - The appearance may not match if there are changes in viewing conditions, e.g., small differences in display equipment.

Consequences cont.

see: Kosslyn, Elements of Graph Design

- Adjacent colors should have different brightness (p. 165)
 - visual system has difficulty registering a boundary that is defined by two colors of same brightness
 - psychological impression of intensity
 - same objective intensity: we see blue as brightest, followed by red, green, yellow and white

Example

don't

Traditional Chronology
of Mayan Civilization

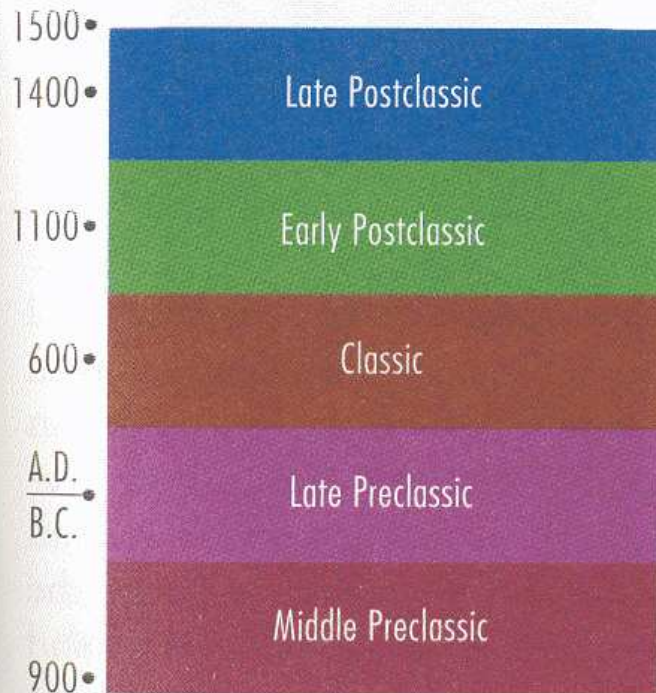

do

Traditional Chronology
of Mayan Civilization

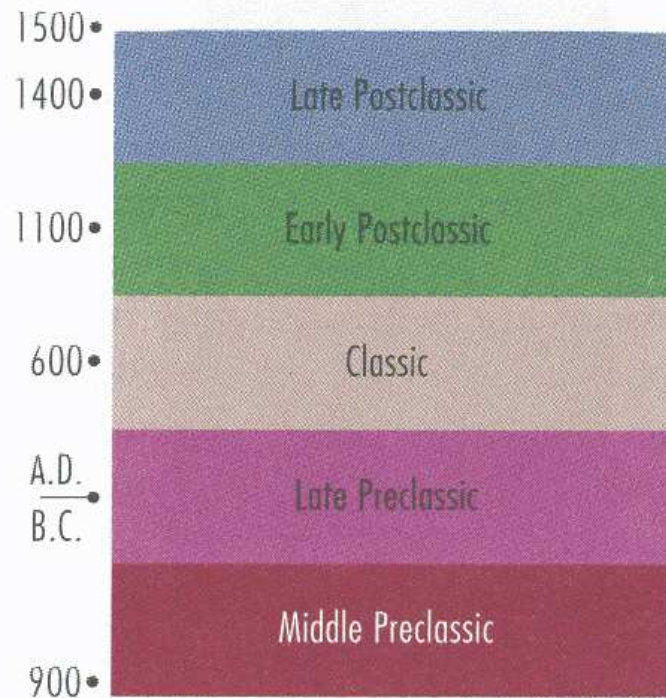

Equal brightnesses make boundaries harder to discern. A given level of intensity appears of different brightnesses to different people, and so differences in intensities must be large enough that all viewers will perceive distinct differences in brightness.

Consequences cont.

- Avoid using red and blue in adjacent regions
 - Lens of the eye cannot focus on two very different wavelengths at the same time
- Avoid cobald blue which is a mixture of blue and red (eye cannot accomodate to both frequencies at the same time)

This is red on blue.

Consequences cont.

- Avoid using hue to represent quantity information (hues are not a psychological continuum, p. 169)

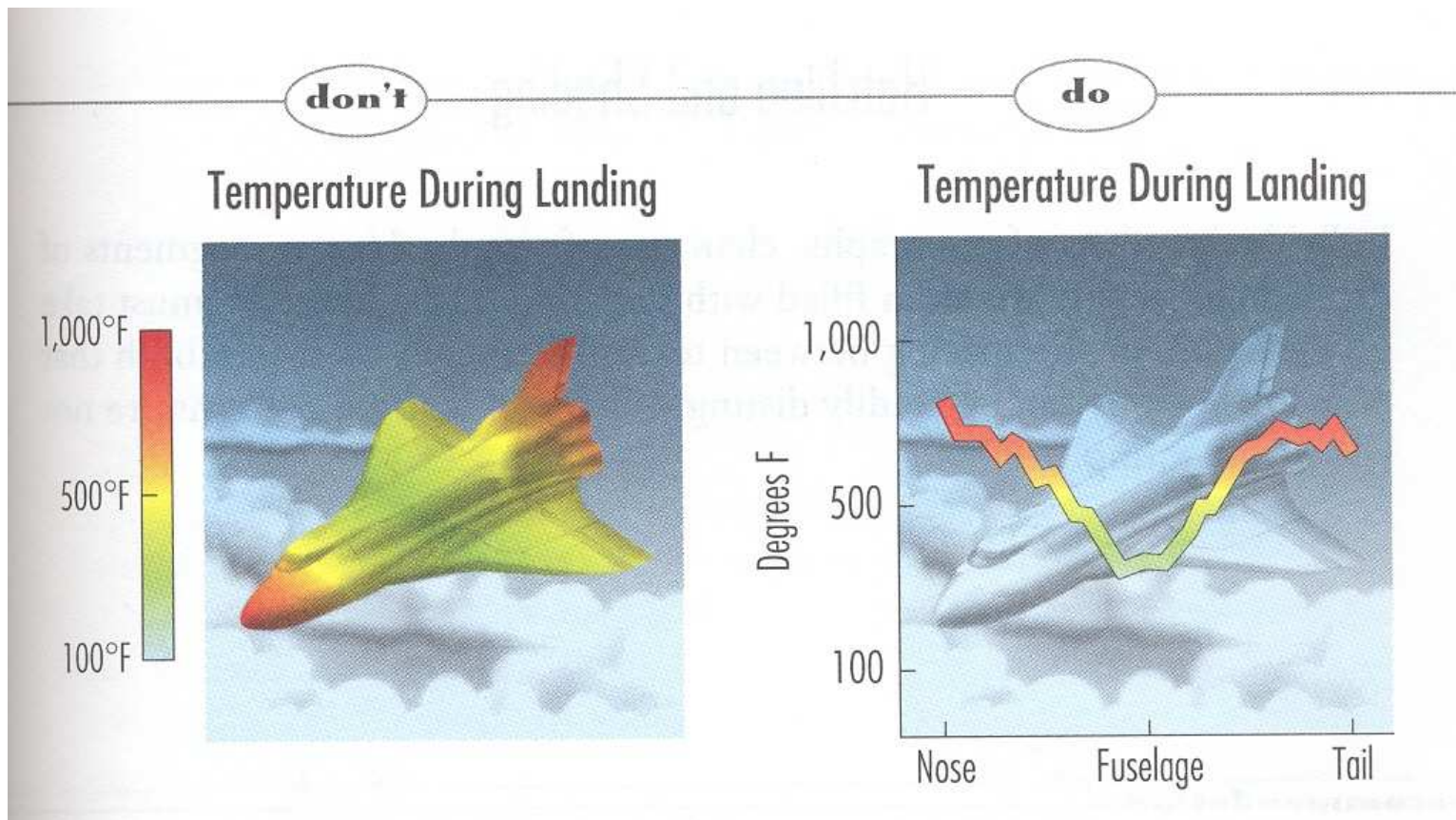

Because differences in hue are not immediately perceived as differences in amount, the reader is required to memorize a key. However, differences in hue can be used to add visual appeal, provided that the principle of compatibility is respected.

Consequences cont.

- Use deeper saturations and greater intensities to indicate greater amounts

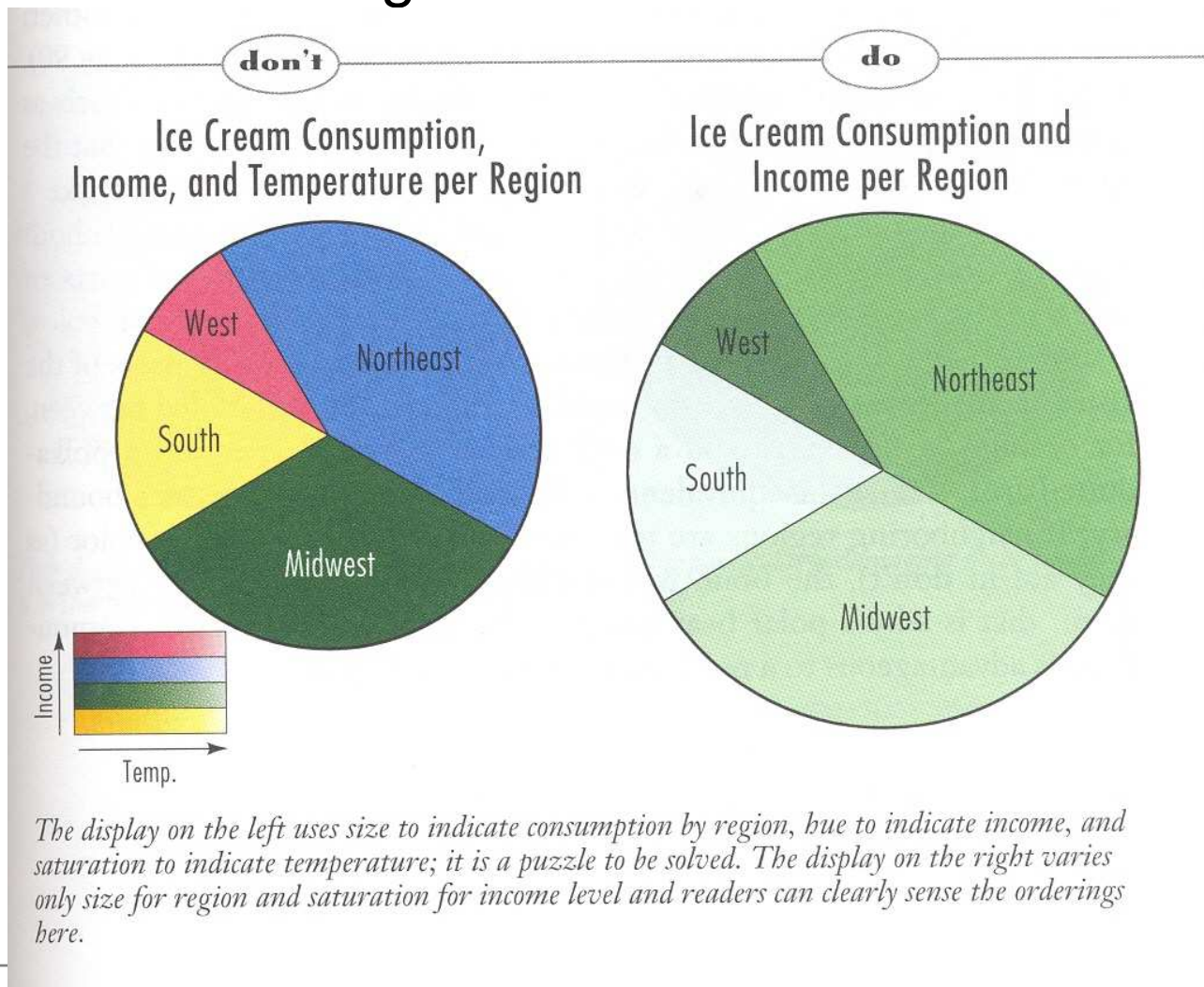

Perceiving Depth

- Two approaches
 - Cue Theory
Information processing approach
Information for depth in the retinal image
 - Ecological Approach (J.J. Gibson)
Information about depth in the environment
(not discussed here)

Cues

- Occulomotor: information from the muscles of the eye; convergence (focusing on something near) and divergence
- Pictorial: overlap, size and height in the field of view, atmospheric perspective, familiar size, Linear perspective
- Movement-produced: motion parallax, deletion and accretion
- Binocular disparity

Height in the Field of View



Linear Perspective

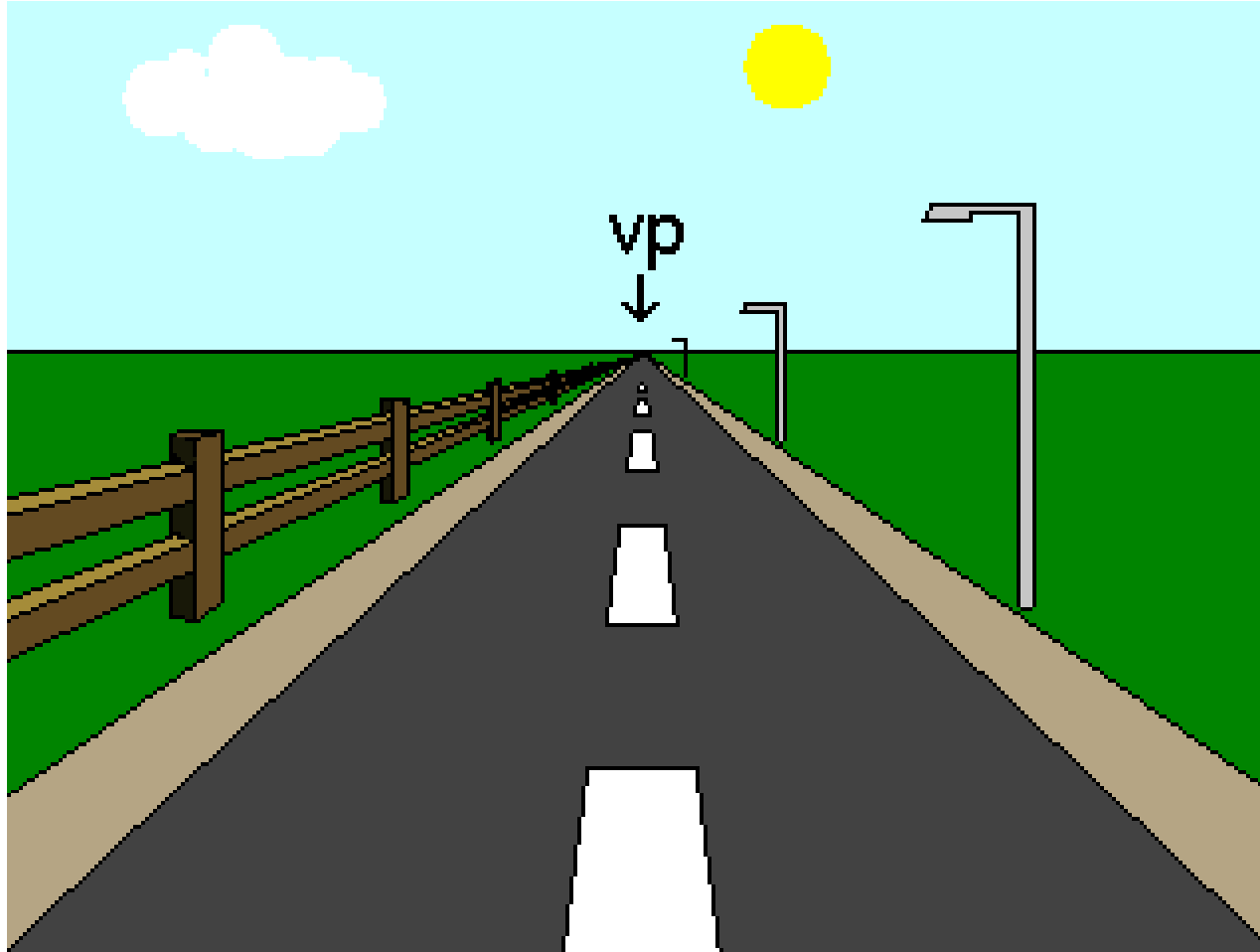

vanishing point

Motion Parallax

- Helmholtz pointed to the role of motion in depth perception.
- As the observer moves relative to the environment nearer surfaces move further and faster in the retinal image than do distant surface and this motion parallax cue provides information about distance.
- Demo:
<http://psych.hanover.edu/Krantz/MotionParallax/MotionParallax.html>

Binocular Disparity

- All other cues: monocular
- Demo: With only your right eye open hold one finger upright about 6 inches in front of you. Then position a finger from your other hand about 6 inches farther back, so that it is completely hidden by the front finger. Now close your right eye and open your left eye, and the rear finger becomes visible.
- Left eye sees from a different point of view!
- Stereoscopic photographs (holograms)

Binocular Disparity cont.

Binocular Disparity

This diagram shows the non-corresponding positions, on each retina, of the images of objects that are further than fixation (yellow and pink circles), or closer than fixation (blue and green circles.) The eyes are fixated on the red square.

The eyes are fixating on the red square.

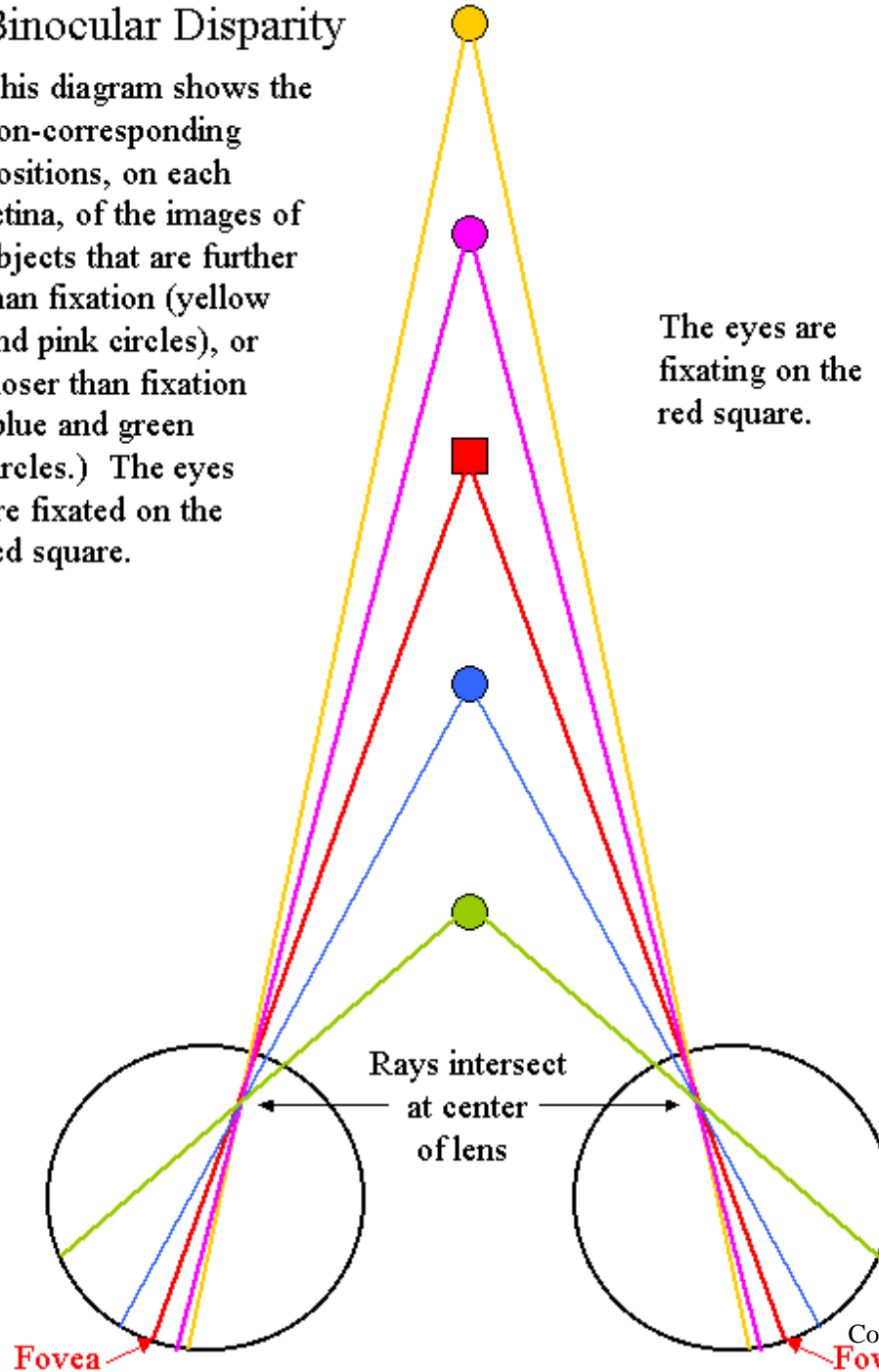

Perceiving Size

- Visual angle (size **and** distance)
- Size illusions due to erroneous depth perception, e.g. Ames room
- Size illusions due to misapplied size constancy (size of an object is perceived constant over different distances), e.g. Müller-Lyer illusion

Ames Room

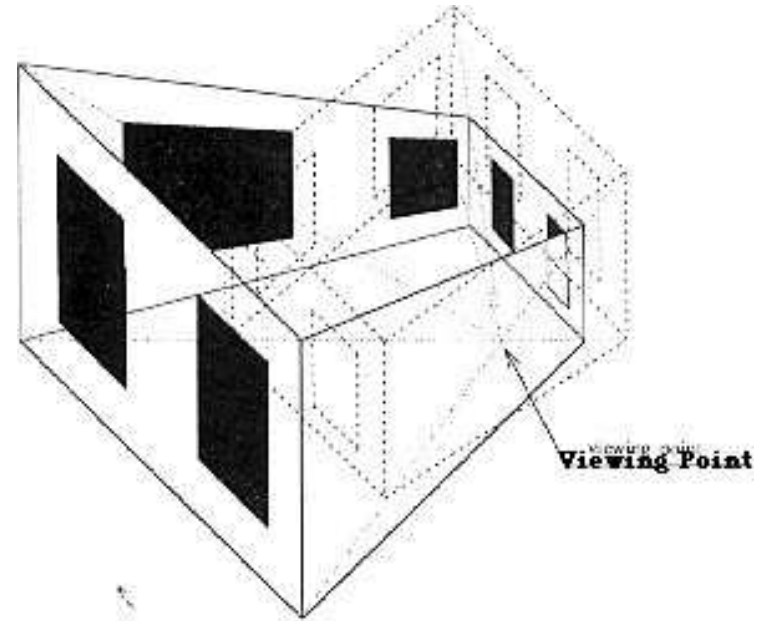

Müller-Lyer Illusion

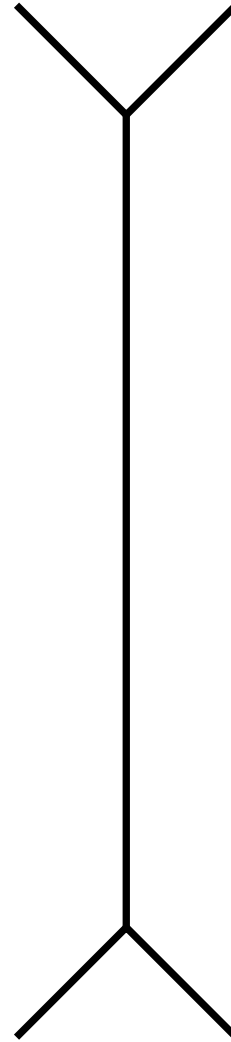
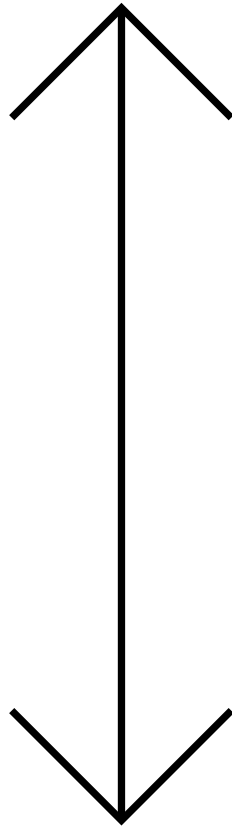

Object Perception

- Perceptual organization: Gestalt principles
 - Max Wertheimer, Wolfgang Köhler und Kurt Kofka, 1920ies
 - to be found on every design webpage
- Information Processing:
 - Two-stage model (Treisman)
 - Recognition by components (Biederman)
 - Marr's vision system

Laws of Organization

- Prägnanz (law of good figure): Every stimulus is seen in such a way that the resulting structure is as simple as possible
- Law of similarity: similar things seem to be grouped together
- Law of good continuation: points that, when connected, result in straight or smoothly curving lines are seen as belonging together, and lines tend to be seen in such a way as to follow the smoothest path
- Law of proximity: things that are near to each other appear to be grouped together
- Law of common fate: things that are moving in the same direction appear to be grouped together
- Law of familiarity: things are more likely to form groups if the groups appear familiar or meaningful

Examples

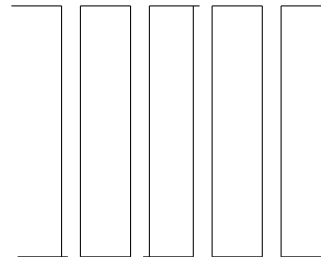
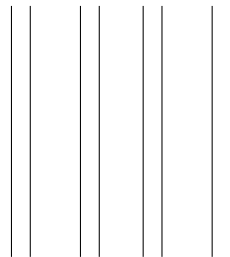
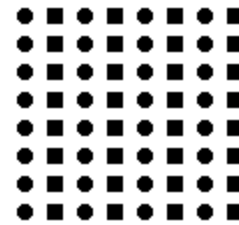
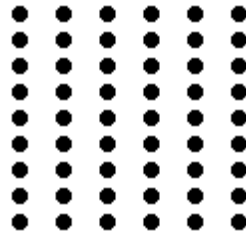
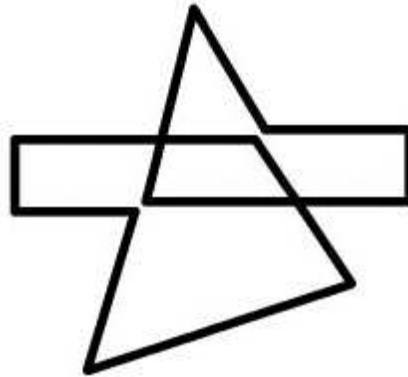
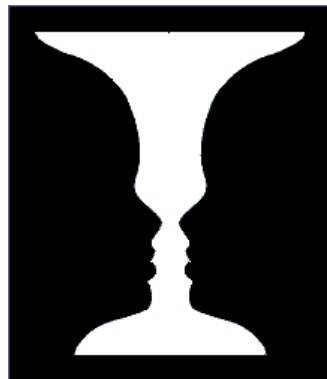

Figure-Ground Separation

Rubin (1915)

- Figure more thinglike and memorable than ground
- Figure seen as being in front
- Ground seen as unformed, seems to extend behind figure
- Contour separating figure from ground seems to belong to figure
- Symmetry, convexity (outward bulbing)



Modern Extensions of Gestalt Psych

- Traditional: Rejection of the idea that perception is constructed from basic sensations; stimulus must be considered as a whole; example based approach; look and see for yourself (descriptive not explanatory)
- Modern experimental approach: e.g., what stimulus properties are responsible for grouping
- Example: Law of similarity (form or orientation)

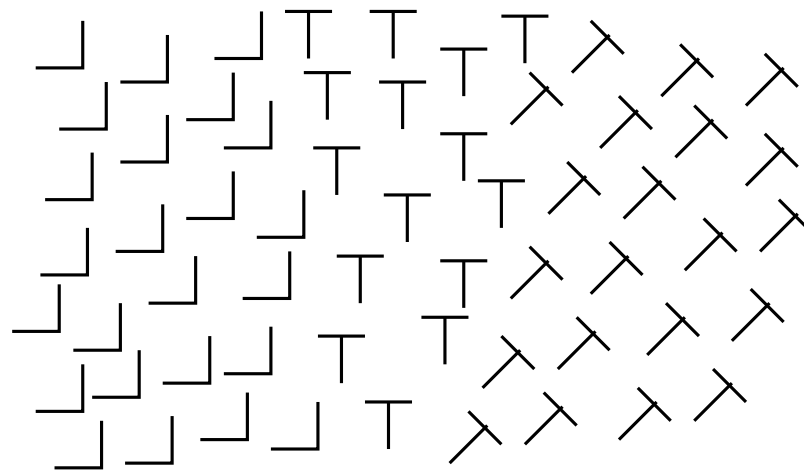

Olson and Attneave 1970

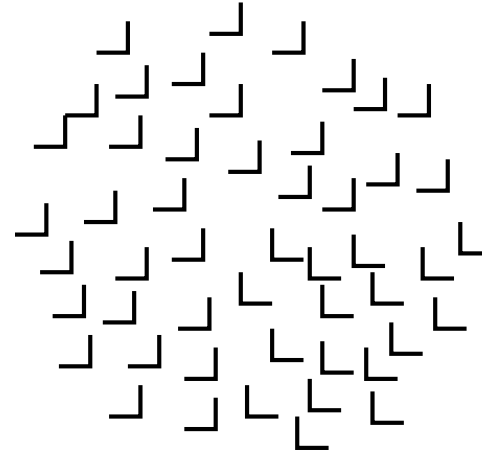
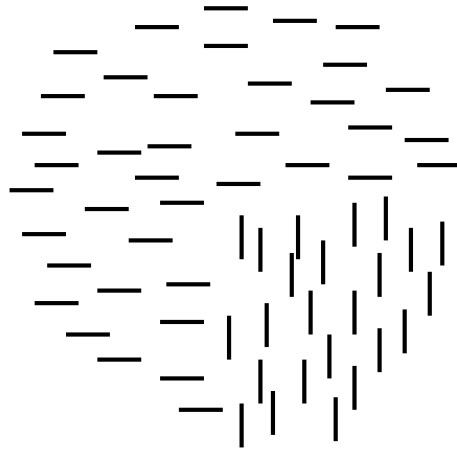

Difference in orientation helps for grouping (RT 0.86 sec vs. 4.09 sec to decide where the odd stimuli are)

Implications for Design

(Kosslyn, Elements of Graph Design)

- Do not use a 3D framework to exaggerate size (p. 217)
- Help to convey accurate representations of the relation between two lines (p. 67)
- Background elements should not be salient (p. 187)
- Background elements must not group with content elements (p. 189)

3D Example

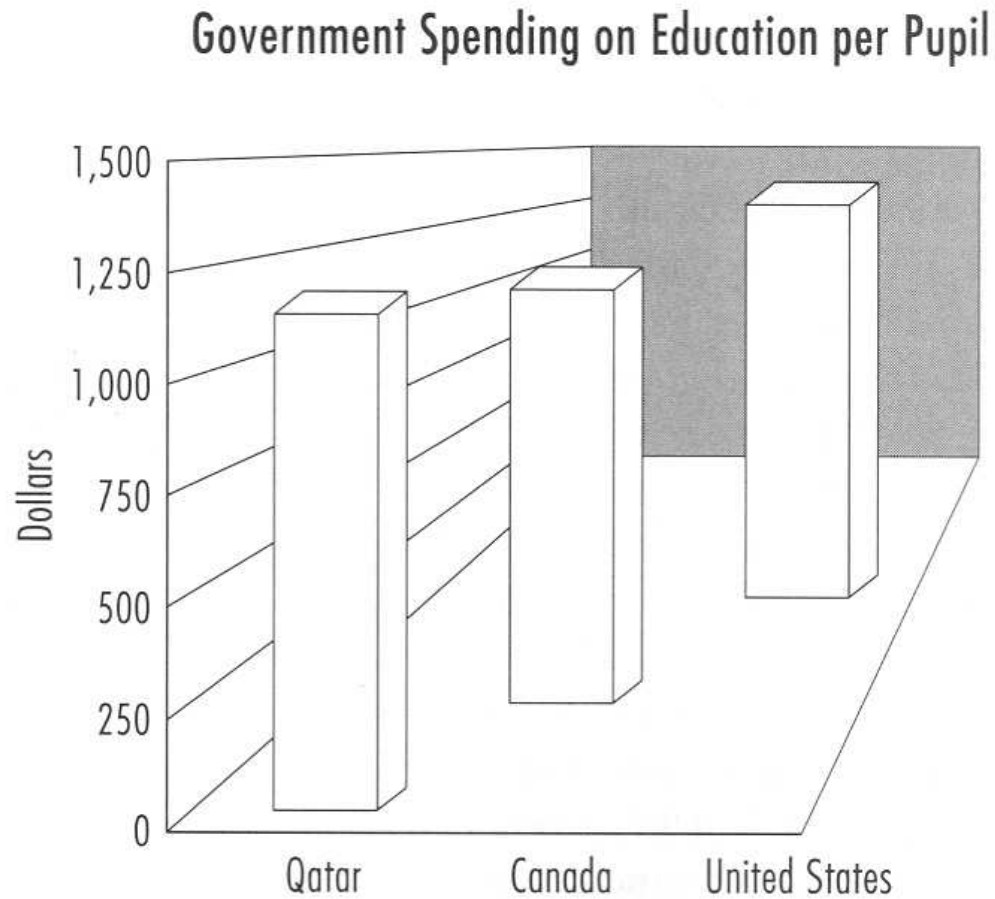

The phenomenon of size constancy leads us to see the farther bars as larger than they are, an impression that is reinforced by the added height on the page of the more distant bars.

Relation between Lines

don't

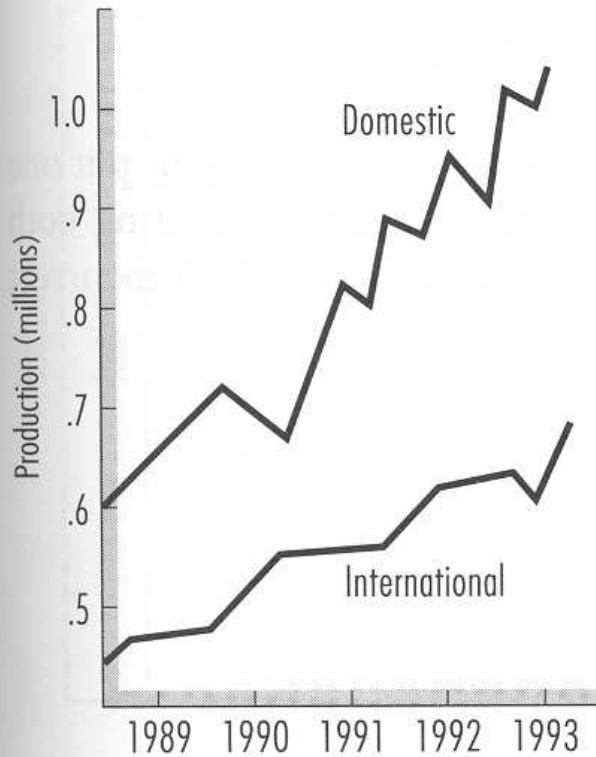

do

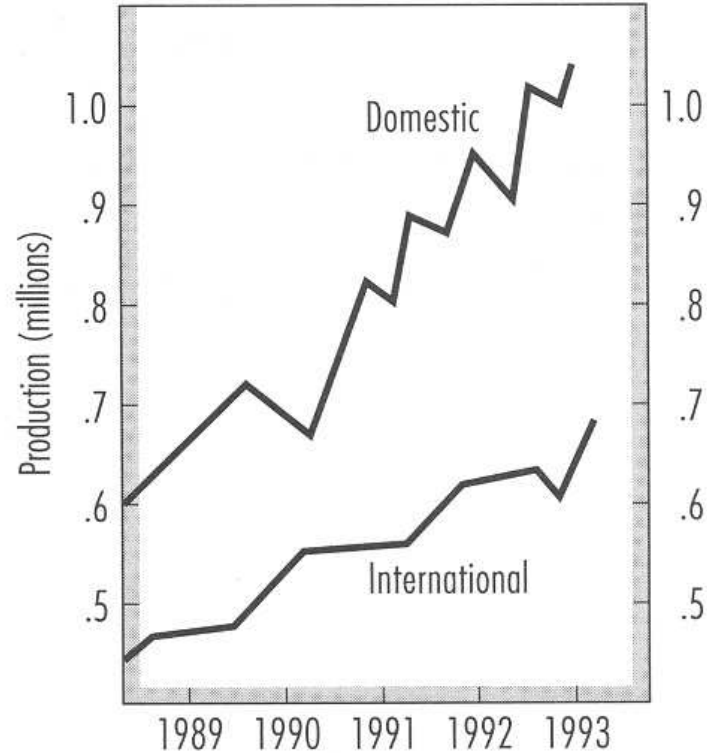

A second Y axis (or an inner grid) helps to convey an accurate visual impression of the relation of two lines at the right side of a graph.

No Salient Background

don't

Cost of a Home

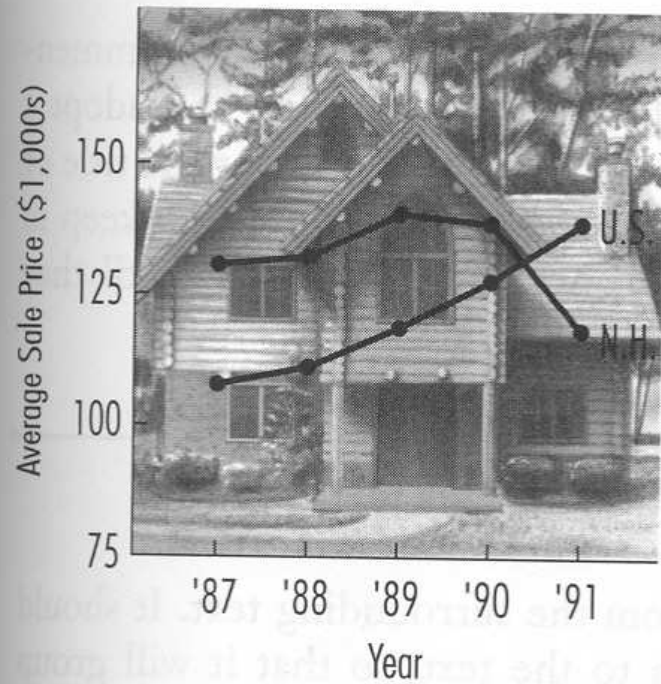

do

Cost of a Home

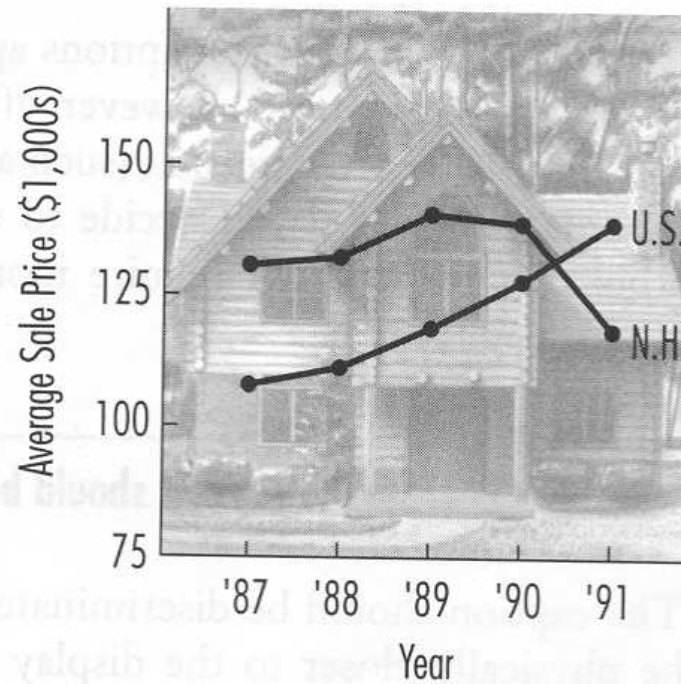

If salience leads readers to see the house before the data, they will have to work to sort out the content.

No Grouping of BG with Content

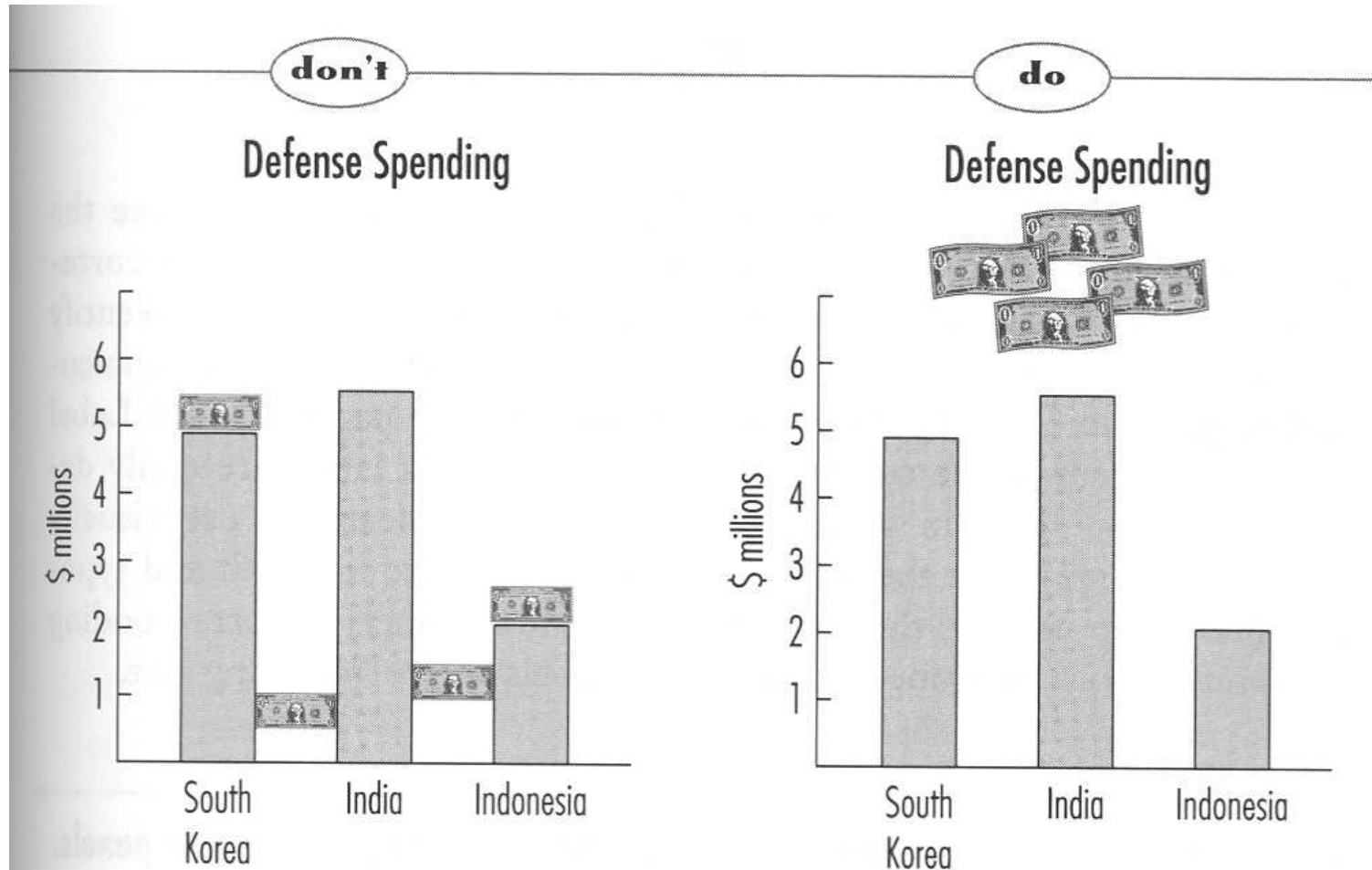

If background elements group with content, the graph is likely to be misinterpreted by a casual reader.